

Dimensional Diagrams

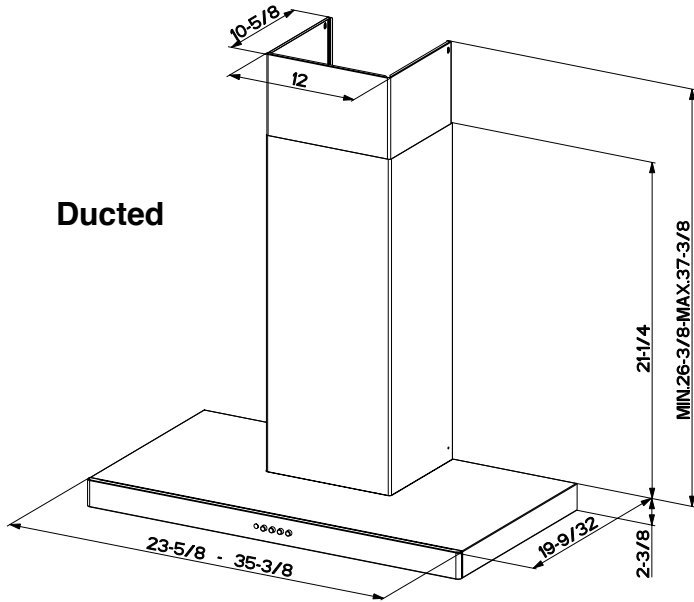

Ducted

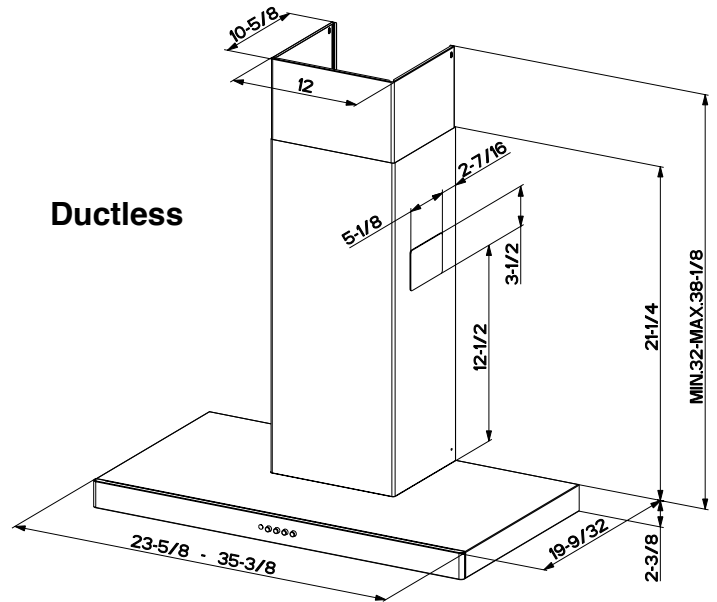

Ductless

Pre-Planning Your Installation - Important: Consult the installation instructions before you begin installing this rangehood.

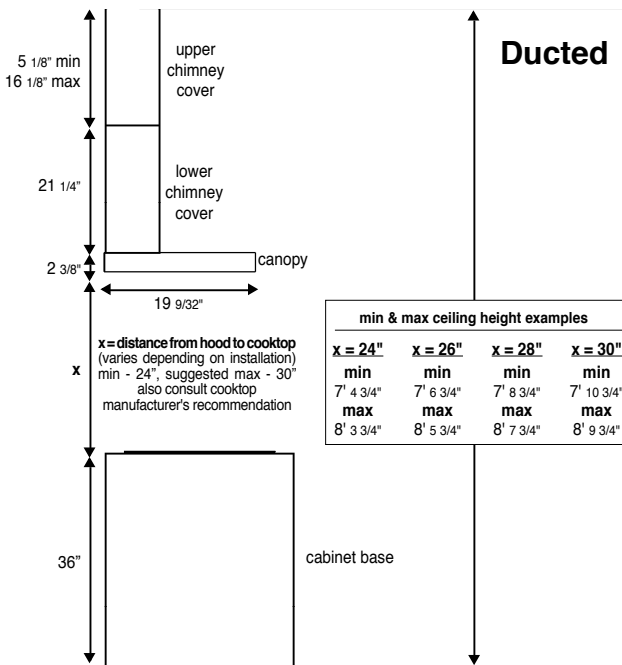

Ducted

For ducted installations, the chimneys can be adjusted for ceilings between 7' 4 3/4" and 8' 9 3/4" depending on the distance between the bottom of the hood and the cooktop (**distance x in Ducted diagram**).

For ductless installations, the chimneys can be adjusted for ceilings between 7' 9 5/8" and 8' 9 3/4" depending on the distance between the bottom of the hood and the cooktop (**distance x in Ductless diagram**).

For shorter ceilings, have the chimney cover(s) cut at a sheet metal shop. For higher ceiling installations, the **High Ceiling Chimney Kit** includes a new 40" upper chimney which would replace the 16 1/8" upper chimney that came with the hood.

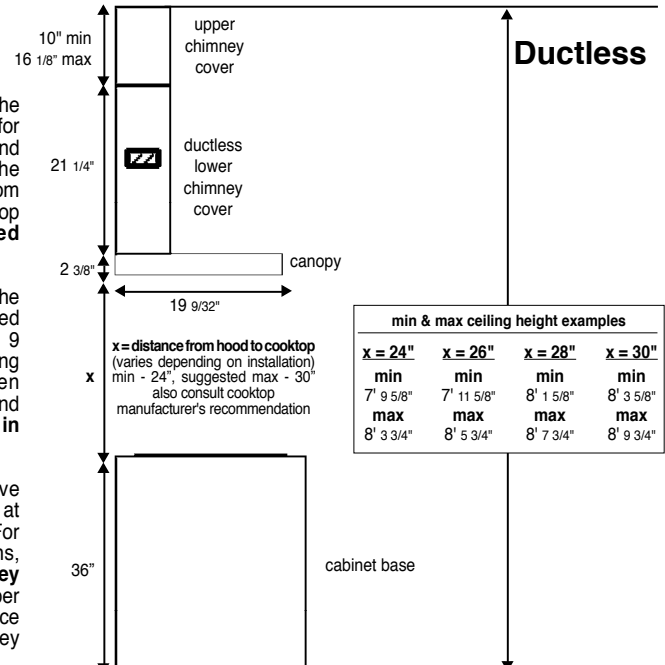

Ductless

Note: If 24" or 30" High Backsplash is being installed, the distance between the bottom of the hood and the cooktop (**distance x in diagram**) is equal to the height of the Backsplash.

Pre-Planning Your Installation - Important: Consult the installation instructions before you begin installing this rangehood.

Make your ductrun as straight and short as possible. The ductrun should not exceed 35 equivalent feet if ducted with the required minimum of 6" round duct. Count 45° angles as 3 feet, 90° elbows as 5 feet, and 90° flat elbows as 12 feet.

For best results, use no more than three 90° elbows. Make sure that there is a **minimum of 24"** of straight duct between elbows if more than one is used. **Do not install two elbows together.** If you must elbow right away, do it as **far away** from the hood's exhaust opening as possible.

WARNING! Product specifications are subject to change without notification. Consult the installation instructions before you begin installing this rangehood.

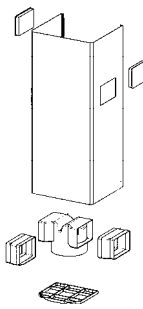

Ductless Installations*

For installations where ductwork is impossible or highly impractical, a **Ductless Conversion Kit** is available. A charcoal filter, which attaches under the blower assembly, absorbs smoke and odors. A ductless diverter assembly directs the air out to a lower chimney with vent grates cut into the sides.

* it is highly recommended that professional style cooking always be vented to the outside.